

Article number: 439500150

Description: Rota-fix shaft-hub connection F150x200
Steel

Note: Self centering. Very high torque

Measures

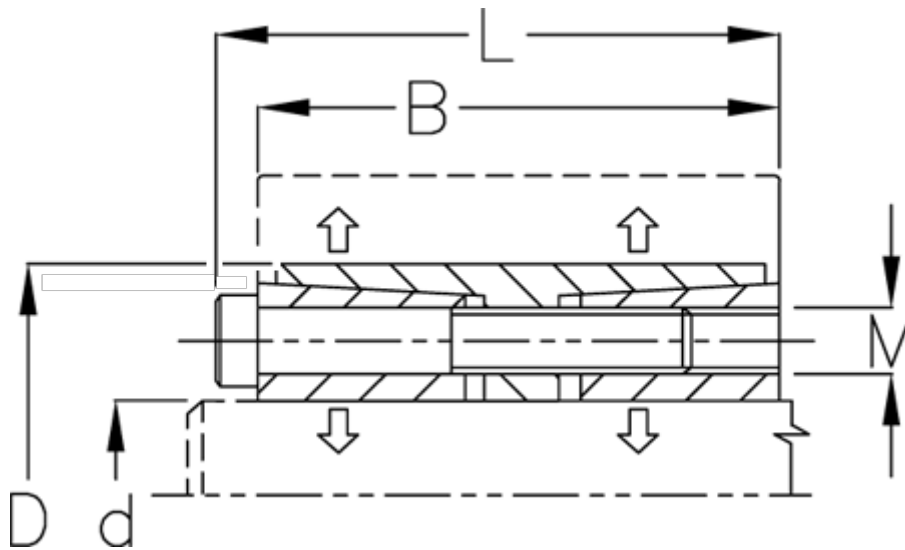

| | |
|---|--------------------|
| B mm | = 114 |
| d H8 mm | = 150 |
| D mm | = 200 |
| Fit tolerance | = Aksel h8, Nav H8 |
| F kN torque | = 900.0 |
| L mm | = 128 |
| M mm | = M14 |
| P N/mm ² surface pressure on shaft/hub | = 120 |

| | |
|-------------------------------|---------------|
| Surface roughness | = R? ? 3.2 µm |
| T N m torque | = 70000 |
| Ts N m bolt tightening torque | = 230.0 |